



# EXHIBITION STAND: OVERVIEW OF STAND PACKAGES

## OVERVIEW OF COMPLETE STAND PACKAGES

Various stand packages are available at Leipzig Book Fair. FAIRNET GmbH as our stand builder is responsible for overall stand construction. All you have to do is arrange or decorate your stand. Below, you can find a comparison of the various complete stand packages, explanations of the options and a calculation example for trade fair rental and fees in each case. Your stand will be positioned as a row, corner, head or block stand according to our capabilities in hall layout and your preferences. See page 13 for more information.



STAND CONSTRUCTION SERVICES	VERSION A	VERSION B	VERSION C
Partition wall system: 100x250 cm (WxH), white*	✓	✓	✓
Fascia, 30 cm high, white	✓	✓	✓
1 Logo (max. 40x30 cm) or 1x lettering (Futura, dark grey), 10 cm high, max. 25 characters		✓	✓
Bookshelves, white (number customizable on request)		✓	✓
Counter with sliding doors, white (Please order door lock separately)		✓	✓
Booth (1 m <sup>2</sup> ) includes lockable door			✓
Furniture: 1 Table, 70x70x72 cm white, 3 chairs, anthracite			✓
Lighting	3 spotlights	✓	✓
Needle felt floor covering, anthracite, 3000	✓	✓	✓
Triple socket (Power connection is obligatory and will be charged separately)	✓	✓	✓

\*other colours available for a fee



# COMPLETE STAND PACKAGES

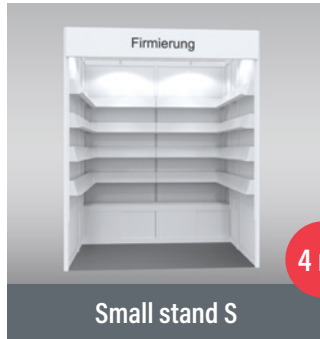

STAND CONSTRUCTION SERVICES	Small stand S	Small stand duo	Small stand M
Partition wall system 100x250 cm (WxH), white*	✓	✓	✓
Fascia, 30 cm high, white	✓	✓	✓
1 Logo (max. 40x30 cm) or 1x lettering (Futura, dark grey), 10 cm high, max. 25 characters	✓	✓	✓
Bookshelves, white (number customizable on request)	✓	✓	✓
Counter with sliding doors, white (Please order door lock separately)	✓	✓	✓
Long-arm spotlight	✓	✓	✓
Needle felt floor covering, anthracite, 3000	✓	✓	✓
Triple socket (Power connection is obligatory and will be charged separately)	✓	✓	✓















\*other colours available for a fee

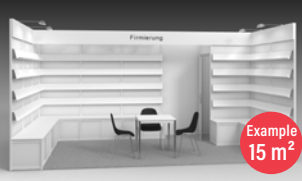

# EXHIBITION STAND: OVERVIEW OF STAND TYPES

Your stand will be positioned as a row, corner, head or block stand according to our capabilities in hall layout and your preferences. At the latest, you will receive your stand confirmation with your stand allocation (from January 2025). The following overview shows examples of the various stand types.

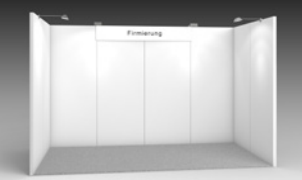
In the interest of the stands across from you, exhibitors with corner, head and block stands may not position a closed wall along an aisle. Please note point 1.7 in our Special Conditions of Participation.

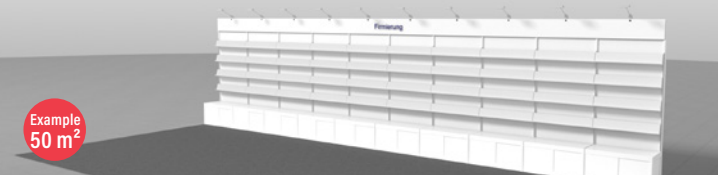
Small stand S 4 m <sup>2</sup>	ROW STAND		CORNER STAND	
Small stand duo 4 m <sup>2</sup>	ROW STAND		CORNER STAND	
Small stand M 6 m <sup>2</sup>	ROW STAND		CORNER STAND	
Complete stand version A	ROW STAND		CORNER STAND	
Complete stand version B	ROW STAND		CORNER STAND	
Complete stand version C	ROW STAND		CORNER STAND	
Complete stand Book Art and Graphic Design	ROW STAND		CORNER STAND	
Head stand with 3 open sides	HEAD STAND			



# COMPLETE STAND PACKAGES

## COMPLETE STAND VERSION A (from 8 m<sup>2</sup>)

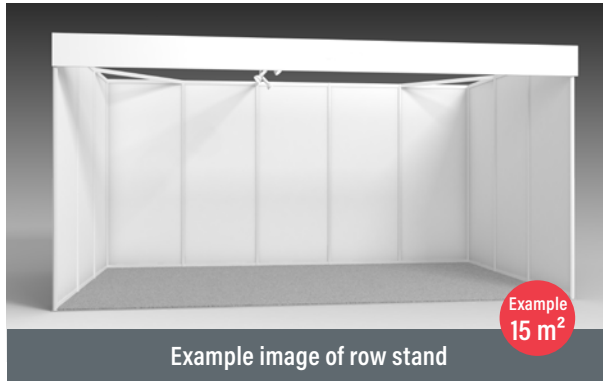

Example image of row stand

Example  
15 m<sup>2</sup>

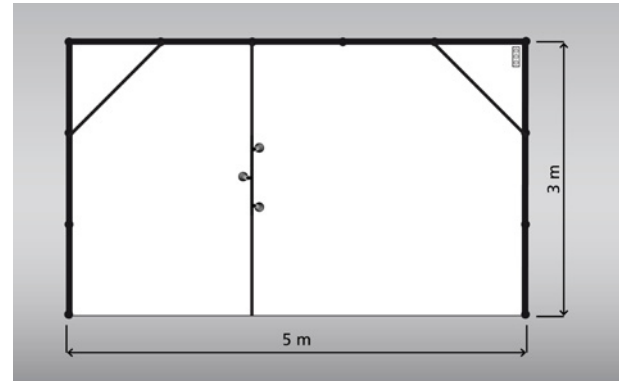

### OUR STAND CONSTRUCTION SERVICES

- | **Partition wall system**, 100x250 cm (WxH), white (other colours available for a fee)
- | **Fascia**, 30 cm high, white
- | **Lighting**, 3 Spotlights
- | **Needle felt floor covering**, anthracite, 3000
- | **Triple socket** (Power connection will be charged separately)

### ADDITIONAL SERVICES

Depending on the registered size of your stand, you will receive a number of free exhibitor passes and can register events for the Leipzig liest reading festival. You can find more information in the Special Conditions of Participation or on pages 23 and 26 onwards.

### CALCULATION EXAMPLE FOR A 15 M<sup>2</sup> EXHIBITION STAND

	REGISTRATION BY 31.08.2024 (SPECIAL PRICE)	REGISTRATION FROM 01.09.2024 (BASIC PRICE)
Trade fair rental incl. stand construction (15 m <sup>2</sup> )	€5,850	€6,450
AUMA fee	€9	€9
Electrical connection (2 kW)	€245	€245
Communication flat rate (i.e. mandatory entry in the exhibitor directory)	€213	€213
Free exhibitor passes (for the main exhibitor based on the stand size + one pass for each co-exhibitor)	4 passes	4 passes
Co-exhibitor fee, where applicable		
Fee for additionally represented companies, where applicable		
Leipzig liest fee 1, where applicable		
<b>TOTAL PRICE</b>	<b>€6,317</b>	<b>€6,917</b>

All prices plus VAT.



# COMPLETE STAND PACKAGES

## COMPLETE STAND VERSION B (from 8 m<sup>2</sup>)

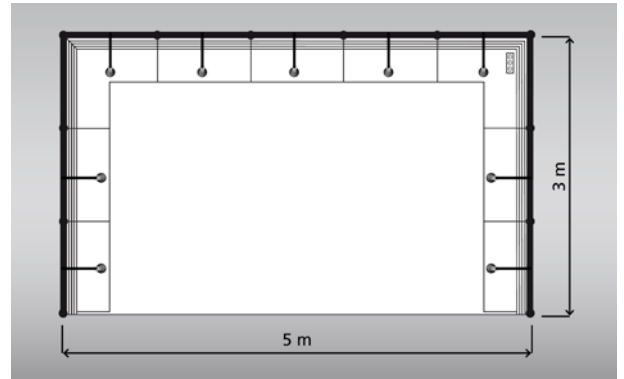
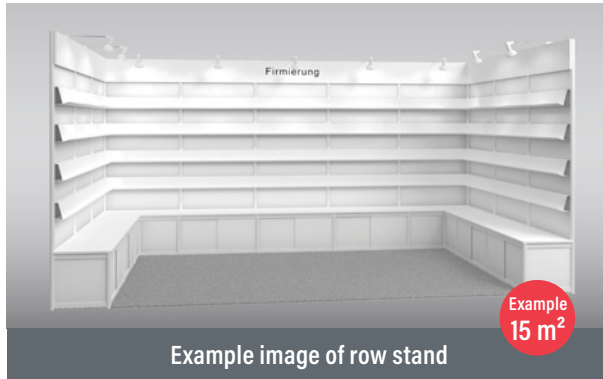

### OUR STAND CONSTRUCTION SERVICES

- | **Partition wall system**, 100x250 cm (WxH), white (other colours available for a fee)
- | **Fascia**, 30 cm high, white
- | **1 Logo (max. 40x30 cm) or 1x lettering** (Futura, dark grey), 10 cm high, max. 25 characters
- | **Bookshelves**, white (number customizable on request)
- | **Counter with sliding doors**, white (Please order door lock separately)
- | **Lighting**: Long-arm spotlight
- | **Needle felt floor covering**, anthracite, 3000
- | **Triple socket** (Power connection will be charged separately)

### ADDITIONAL SERVICES

Depending on the size of your stand, you will receive a number of free exhibitor passes and can register events for the Leipzig liest reading festival. You can find more information in the Special Conditions of Participation or on pages 23 and 26 onwards.

### CALCULATION EXAMPLE FOR A 15 M<sup>2</sup> EXHIBITION STAND

	REGISTRATION BY 31.08.2024 (SPECIAL PRICE)	REGISTRATION FROM 01.09.2024 (BASIC PRICE)
Trade fair rental incl. stand construction (15 m <sup>2</sup> )	€7,035	€7,755
AUMA fee	€9	€9
Electrical connection (2 kW)	€245	€245
Communication flat rate (i.e. mandatory entry in the exhibitor directory)	€213	€213
Free exhibitor passes (for the main exhibitor based on the stand size + one pass for each co-exhibitor)	4 passes	4 passes
Co-exhibitor fee, where applicable		
Fee for additionally represented companies, where applicable		
Leipzig liest fee 1, where applicable		
<b>TOTAL PRICE</b>	<b>€ 7,502</b>	<b>€ 8,222</b>

All prices plus VAT.



# COMPLETE STAND PACKAGES

## COMPLETE STAND VERSION C (from 9 m<sup>2</sup>)

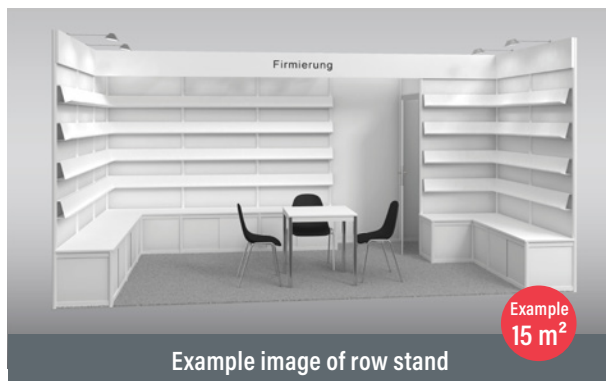

Example image of row stand

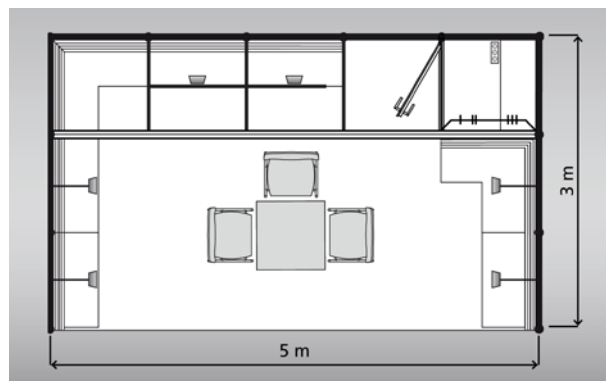

### OUR STAND CONSTRUCTION SERVICES

- | **Partition wall system**, 100x250 cm (WxH), white (other colours available for a fee)
- | **Fascia**, 30 cm high, white
- | **1 Logo (max. 40x30 cm) or 1x lettering** (Futura, dark grey), 10 cm high, max. 25 characters
- | **Bookshelves**, white (number customizable on request)
- | **Counter with sliding doors**, white (Please order door lock separately)
- | **Booth** (1 m<sup>2</sup>) Includes lockable door
- | **Furniture:**, 1 Table, 70x70x72 cm white, 3 Chairs, anthracite
- | **Lighting**, Spotlights
- | **Needle felt floor covering**, anthracite, 3000
- | **Triple socket** (Power connection will be charged separately)

### ADDITIONAL SERVICES

Depending on the size of your stand, you will receive a number of free exhibitor passes and can register events for the Leipzig liest reading festival. You can find more information in the Special Conditions of Participation or on pages 23 and 26 onwards.

### CALCULATION EXAMPLE FOR A 15 M<sup>2</sup> EXHIBITION STAND

	REGISTRATION BY 31.08.2024 (SPECIAL PRICE)	REGISTRATION FROM 01.09.2024 (BASIC PRICE)
Trade fair rental incl. stand construction (15 m <sup>2</sup> )	€9,075	€10,005
AUMA fee	€9	€9
Electrical connection (2 kW)	€245	€245
Communication flat rate (i.e. mandatory entry in the exhibitor directory)	€213	€213
Free exhibitor passes (for the main exhibitor based on the stand size + one pass for each co-exhibitor)	4 passes	4 passes
Co-exhibitor fee, where applicable		
Fee for additionally represented companies, where applicable		
Leipzig liest fee 1, where applicable		
<b>TOTAL PRICE</b>	<b>€9,542</b>	<b>€10,472</b>

All prices plus VAT.



# COMPLETE STAND PACKAGES

## SMALL STAND S (4 m<sup>2</sup>)

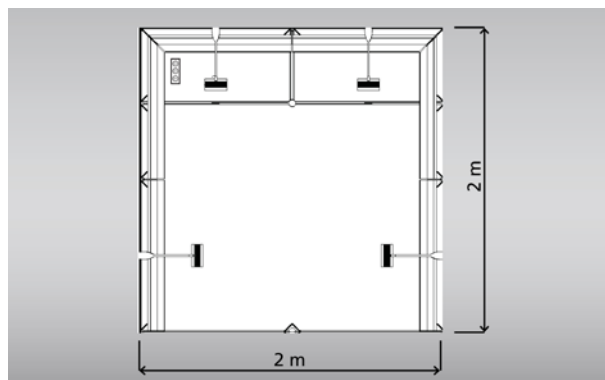
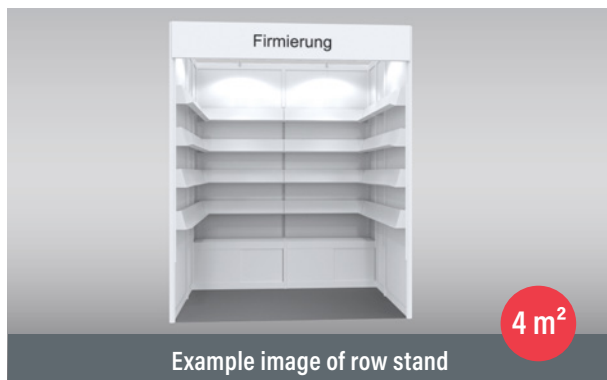

### OUR STAND CONSTRUCTION SERVICES

- | **Partition wall system**, 100x250 cm (WxH), white (other colours available for a fee)
- | **Fascia**, 30 cm high, white
- | **1 Logo (max. 40x30 cm) or 1x lettering** (Futura, dark grey), 10 cm high, max. 25 characters
- | **Bookshelves**, white (number customizable on request)
- | **Counter with sliding doors**, white (Please order door lock separately)
- | **Lighting**, Spotlights
- | **Needle felt floor covering**, anthracite, 3000
- | **Triple socket** (Power connection will be charged separately)

### ADDITIONAL SERVICES

Based on the size of your stand, you will receive a number of free exhibitor passes (2) and can register your event for the Leipzig liest reading festival (1 event in accordance with the exhibition space key). You can find more information in the Special Conditions of Participation or on pages 23 and 26 onwards.

### CALCULATION EXAMPLE FOR A 4 M<sup>2</sup> EXHIBITION STAND

	REGISTRATION BY 31.08.2024 (SPECIAL PRICE)	REGISTRATION FROM 01.09.2024 (BASIC PRICE)
Trade fair rental incl. stand construction (4 m <sup>2</sup> )	€804	€888
AUMA fee	€2.40	€2.40
Electrical connection (2 kW)	€187	€187
Communication flat rate (i.e. mandatory entry in the exhibitor directory)	€98	€98
Free exhibitor passes (for the main exhibitor based on the stand size + one pass for each co-exhibitor)	2 passes	2 passes
Co-exhibitor fee, where applicable		
Fee for additionally represented companies, where applicable		
Leipzig liest fee 1, where applicable		
<b>TOTAL PRICE</b>	<b>€1,091.40</b>	<b>€1,175.40</b>

All prices plus VAT.



# COMPLETE STAND PACKAGES

## SMALL STAND DUO (4 m<sup>2</sup>)

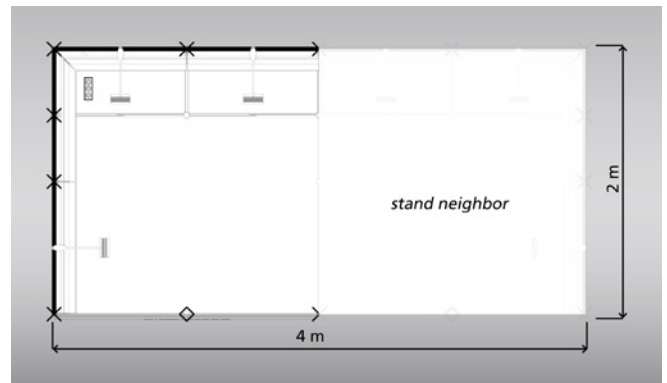
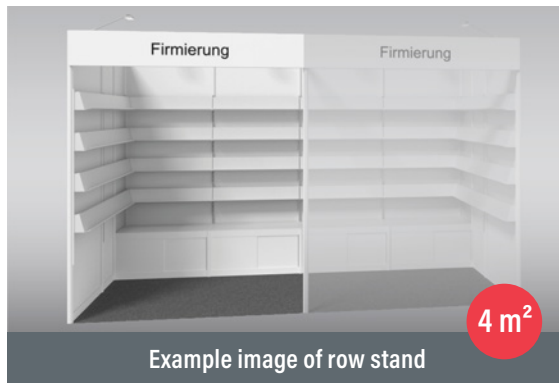

### OUR STAND CONSTRUCTION SERVICES

- | **Partition wall system**, 100x250 cm (WxH), white (other colours available for a fee)
- | **Fascia**, 30 cm high, white
- | **1 Logo (max. 40x30 cm) or 1x lettering** (Futura, dark grey), 10 cm high, max. 25 characters
- | **Bookshelves**, white (number customizable on request)
- | **Counter with sliding doors**, white (Please order door lock separately)
- | **Lighting**, Spotlights
- | **Needle felt floor covering**, anthracite, 3000
- | **Triple socket** (Power connection will be charged separately)

### ADDITIONAL SERVICES

Based on the size of your stand, you will receive a number of free exhibitor passes (2) and can register your event for the Leipzig liest reading festival (1 event in accordance with the exhibition space key). You can find more information in the Special Conditions of Participation or on pages 23 and 26 onwards.

CALCULATION EXAMPLE FOR A 4 M <sup>2</sup> EXHIBITION STAND	REGISTRATION BY 31.08.2024 (SPECIAL PRICE)	REGISTRATION FROM 01.09.2024 (BASIC PRICE)
Trade fair rental incl. stand construction (4 m <sup>2</sup> )	€1,092	€1,208
AUMA fee	€2.40	€2.40
Electrical connection (2 kW)	€187	€187
Communication flat rate (i.e. mandatory entry in the exhibitor directory)	€98	€98
Free exhibitor passes (for the main exhibitor based on the stand size + one pass for each co-exhibitor)	2 passes	2 passes
Co-exhibitor fee, where applicable		
Fee for additionally represented companies, where applicable		
Leipzig liest fee 1, where applicable		
<b>TOTAL PRICE</b>	<b>€1,379.40</b>	<b>€1,495.40</b>

All prices plus VAT.





# COMPLETE STAND PACKAGES

## SMALL STAND M (6 m<sup>2</sup>)

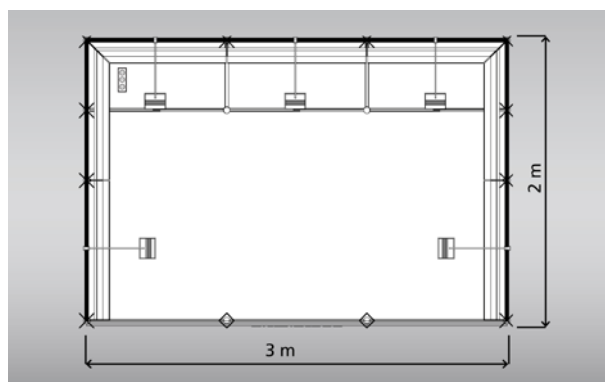
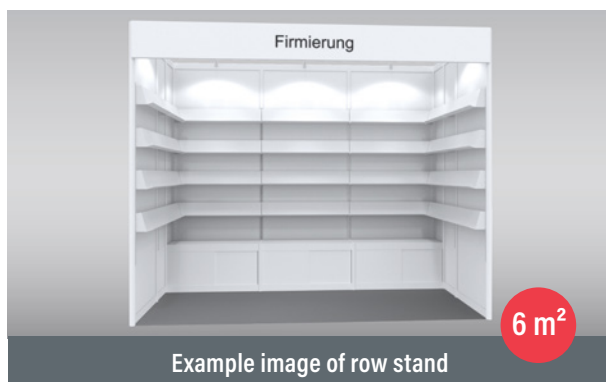

### OUR STAND CONSTRUCTION SERVICES

- | **Partition wall system**, 100x250 cm (WxH), white (other colours available for a fee)
- | **Fascia**, 30 cm high, white
- | **1 Logo (max. 40x30 cm) or 1x lettering** (Futura, dark grey), 10 cm high, max. 25 characters
- | **Bookshelves**, white (number customizable on request)
- | **Counter with sliding doors**, white (Please order door lock separately)
- | **Lighting**: Long-arm spotlight
- | **Needle felt floor covering**, anthracite, 3000
- | **Triple socket** (Power connection will be charged separately)

### ADDITIONAL SERVICES

Based on the size of your stand, you will receive a number of free exhibitor passes (3) and can register your events for the Leipzig liest reading festival (2 events in accordance with the exhibition space key). You can find more information in the Special Conditions of Participation or on pages 23 and 26 onwards.

### CALCULATION EXAMPLE FOR A 6 M<sup>2</sup> EXHIBITION STAND

	REGISTRATION BY 31.08.2024 (SPECIAL PRICE)	REGISTRATION FROM 01.09.2024 (BASIC PRICE)
Trade fair rental incl. stand construction (6 m <sup>2</sup> )	€1,290	€1,422
AUMA fee	€3.60	€3.60
Electrical connection (2 kW)	€187	€187
Communication flat rate (i.e. mandatory entry in the exhibitor directory)	€98	€98
Free exhibitor passes (for the main exhibitor based on the stand size + one pass for each co-exhibitor)	3 passes	3 passes
Co-exhibitor fee, where applicable		
Fee for additionally represented companies, where applicable		
Leipzig liest fee 1, where applicable		
<b>TOTAL PRICE</b>	<b>€1,578.60</b>	<b>€1,710.60</b>

All prices plus VAT.